



**RAYCHEM**  
TraceTek

# TTSIM-2

## nVent RAYCHEM TraceTek sensor interface module with LCD and relay installation/operation instructions



### APPROVALS AND CERTIFICATIONS



General Signaling Equipment  
76LJ



Only AC versions are UL listed and VDE Certified.  
For DC models use a Listed Class 2 Power Supply.

### PRODUCT INFORMATION

<b>TTSIM-2</b>	22 to 26 Vac, 50/60 Hz, 3 W (SELV level for Europe)
<b>TTSIM-2-120</b>	92 to 132 Vac, 50/60 Hz, 3 W
<b>TTSIM-2-230</b>	216 to 253 Vac, 50/60 Hz, 3 W
<b>TTSIM-2-12VDC</b>	12 Vdc +/- 10%, 2 W
<b>TTSIM-2-24VDC</b>	24 Vdc +/- 10%, 2 W
<b>Relay contacts</b>	Form C (SPDT), 250 Vac/30 Vdc at 2 Amps maximum (30 V SELV level for Europe)
<b>Installation categories</b>	Overvoltage Category II Pollution Degree 2
<b>Storage temperature</b>	-18°C to 60°C (0°F to 140°F)
<b>Operating temperature</b>	0°C to 50°C (32°F to 122°F)
<b>Enclosure</b>	NEMA 1; IP20 (NEMA 4X / IP 56 with optional enclosure)

### GENERAL INFORMATION

Please read these instructions and keep them in a safe place. These instructions must be followed carefully to ensure proper operation.

The nVent RAYCHEM TraceTek TTSIM-2 has been designed for use with TraceTek sensing cables, point sensors and normally open, dry contact devices (float switch, pressure or vacuum switch, optical probe with adapter, limit switch, etc.). Up to 150 m (500 ft) of sensor cable can be monitored by the TTSIM-2.

The TTSIM-2 is designed for installation in ordinary (non-hazardous) areas. The TTSIM-2 has five small LED's to indicate power, status and communications activity, as well as a relay with SPDT contacts. The TTSIM-2 can be used as a stand-alone leak detection alarm, or connected to a host system (TraceTek TTDM-128, computer, or control automation system) via simple, shielded twisted pair RS-485 serial communication wiring.

### TOOLS REQUIRED

- Small flat blade screwdriver
- Small needle nose pliers
- Tools to mount DIN rail or enclosure

### INSTALLATION ITEMS (NOT SUPPLIED)

- 35 mm DIN rail mounting strip (for wall mounts or interior of large control cabinets) and attachment hardware.
- TT-RS485 power and telemetry cable.
- Optional TTSIM-ENC-4X-OUTDOORS environmental enclosure for outdoor or corrosive environments, or TTSIM-ENC-4X-INDOORS enclosure with clear cover for indoor, non-corrosive environments.

### STORAGE

Keep the TTSIM-2 modules in a dry place prior to installation. Avoid damage to components.

### ADDITIONAL ITEMS

An agency-approved zener barrier must be used where sensing cable connected to the TTSIM-2 will be located in Class1 Div 1 (Zone 0 or 1 in Europe) Hazardous Locations.

## Installing the TTSIM-2

**Note:** To avoid damage to the TTSIM-2, store the unit in its packaging until ready to install.

### Selecting the mounting position

Choose a location where the module will be protected from the elements, temperature extremes or heavy vibration. The TTSIM-2 is designed to be snapped onto standard 35 mm DIN rail. Existing electrical or instrumentation cabinets with spare rail space make good mounting locations. It is also possible to install a small section of DIN rail directly on a wall or cabinet surface and mount the TTSIM-2 in any location as long as it does not create a tripping hazard or expose the TTSIM-2 to impact damage. The TTSIM-2 should be mounted within 1200 m (4000 ft) wire run from the controlling TTDM-128 or control system host. Contact the factory for methods to increase the wire run distance beyond 1200 m.

**Important:** The TTSIM-2 is an electronic unit. Take the following precautions to avoid damage to electronic components:

- Handle with care and avoid mechanical shock and impact.
- Keep dry.
- Avoid exposure to static electricity by touching a nearby piece of grounded equipment or water pipe prior to handling the TTSIM-2.
- Avoid contact with metal filings, grease, pipe dope and other contaminants.

### Mounting the TTSIM-2 module (without NEMA 4X Enclosure – Figure 1)

- Secure a sufficient length of DIN rail to the desired mounting surface, or locate an existing DIN rail with sufficient space to install the TTSIM-2.
- Remove the TTSIM-2 from its packaging and snap onto the DIN rail with the release tab towards the bottom.

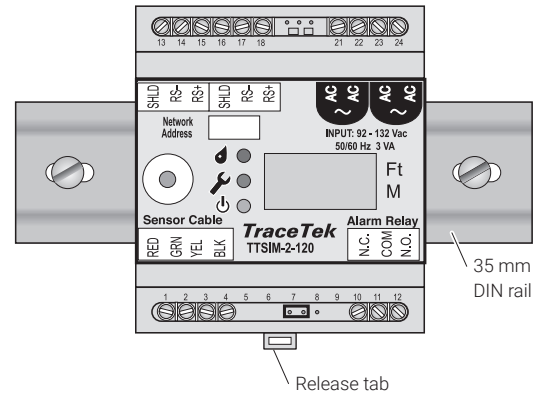

Figure 1. DIN rail mount

### Mounting the TTSIM-2 module in the optional NEMA 4X Enclosure – Figure 2

- Plan conduit alignment and drill holes as necessary.
- A typical outdoor or harsh environment installation will require three holes in the TTSIM-ENC: one for inbound power and telemetry, one for outbound power and telemetry and one for the sensor cable leader. See Figure 2.
- Secure the TTSIM-ENC to any convenient vertical surface using the four corner mounting holes and hardware suitable for the selected surface.
- Rough-in conduit as required and pull the cables for power and telemetry. Leave approximately 20 cm (8 in) for connection to TTSIM-2 terminals. Pull in the sensor circuit leader cable.
- In order to provide maximum electrostatic discharge protection, and to be CE compliant, the DIN rail must be grounded.

**Note:** Rough-in and final connections do not have to be completed at the same time, however make sure to replace the cover and tighten the cover screws if the enclosure will be left in a partially installed condition overnight or longer.

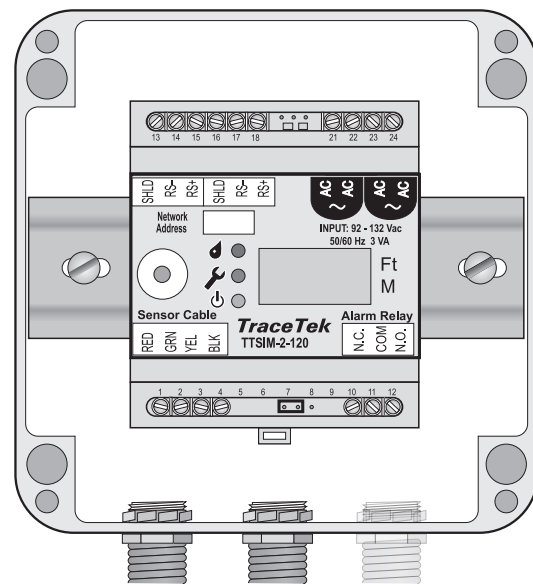

Figure 2. NEMA 4X enclosure

## Power Supply Options

The TTSIM-2 has several power supply options available. Depending on the version being installed and local regulations, the wiring requirements may vary. In all cases, be sure that each

TTSIM-2 receives supply voltage from one and only one source. **Important:** Observe polarity of DC connection if using 12 Vdc or 24 Vdc versions.

## Connections for Power and Telemetry

TTSIM-2 communicates all alarm and status messages via RS-485 shielded twisted pair telemetry. Two of the four conductors in the power/telemetry cable are used for telemetry and the other two wires may be used to provide the supply voltage. Alternatively, separate wiring may be used for the supply voltage, as shown in Figure 3.

For all TTSIM-2 modules except the last one, there will be an incoming cable (from the TTDM-128 or other host system) and an outgoing cable (to the next TTSIM-2).

- Strip a sufficient amount of the jacket insulation and shielding to expose about 2.5 cm (1 in) of the four wires.
- Strip the primary wires to expose approximately 6 mm (1/4 in) of conductor and make the following connections: (see Figure 3)

Terminal	Color	Item	
13	—	Shield Drain Wire	[Shielded twisted pair from TTDM-128, Host, or previous TTSIM]
14	Black	RS-485 (-)	
15	Red	RS-485 (+)	
16	—	Shield Drain Wire	
17	Black	RS-485 (-)	[Shielded twisted pair to next TTSIM]
18	Red	RS-485 (+)	
21	Green	AC/DC Supply	From source or previous TTSIM*
22	White	AC/DC Supply	
23	[Green]	AC/DC Supply	[To next TTSIM]
24	[White]	AC/DC Supply	

\* Power supply voltage must be within range specified on TTSIM-2 label.

Items in square brackets [ ] are optional. When using TraceTek TT-RS485 power and telemetry cable for power supply distribution, follow the color codes indicated in brackets.

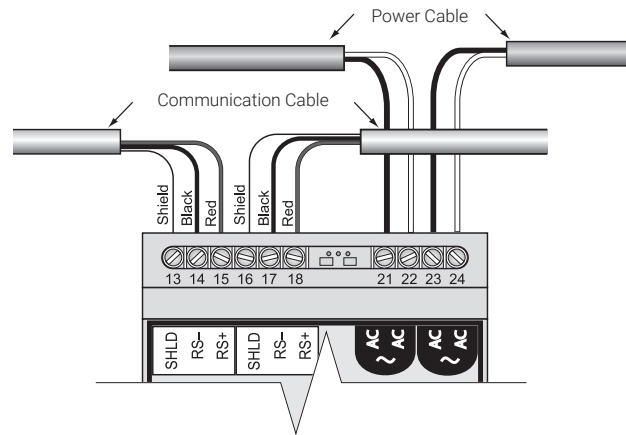

Figure 3. Power and Telemetry Connections

## Connections for Alarm Relay

The software programmable TTSIM-2 relay contacts may be used for local or remote annunciation, to control a valve or other device, or for connection to a control automation system contact input. The relay can be programmed to alarm on leak only; on either leak or fault; or on leak, fault, or service required. The relay can also be programmed to be ON (coil energized) or OFF (coil de-energized) to signal an alarm (see table below). The relay can be programmed using either a TTDM-128 or a PC running TraceTek TT-SUPERVISOR software.

Programmed Alarm State	Alarm Condition	Status at Terminals	
		10-11	11-12
On (default)	No alarms	closed	open
	Alarm	open	closed
	Loss of power	closed	open
Off	No alarms	open	closed
	Alarm	closed	open
	Loss of power	closed	open

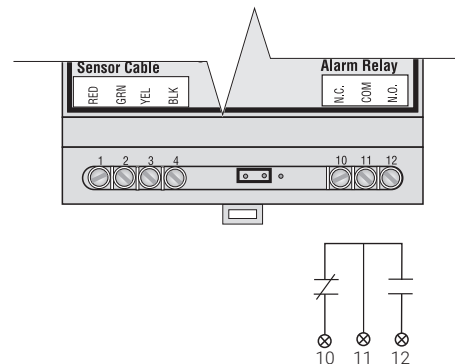

Figure 4. Alarm Relay Connections (shown in power off condition)

### Place the End of Line Jumper in the correct position

If the TTSIM-2 will be connected to a host for communication, it is necessary to set the End of Line Jumper in the correct position as follows:

- On the last TTSIM-2 in the circuit, place the jumper as shown in Figure 5a.
- On all other TTSIM's in the circuit, place the jumper as shown in Figure 5b.

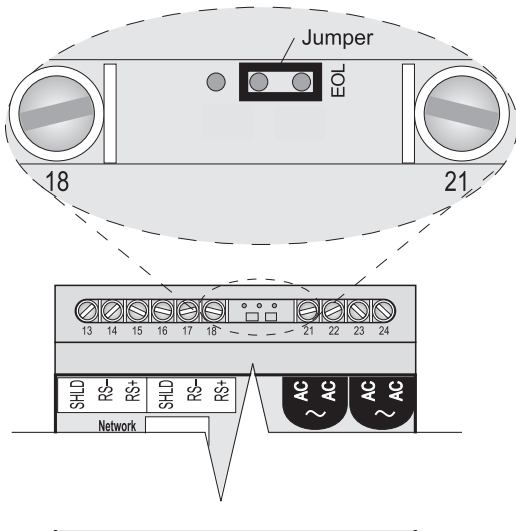

Figure 5a. End of Line Jumper for last TTSIM

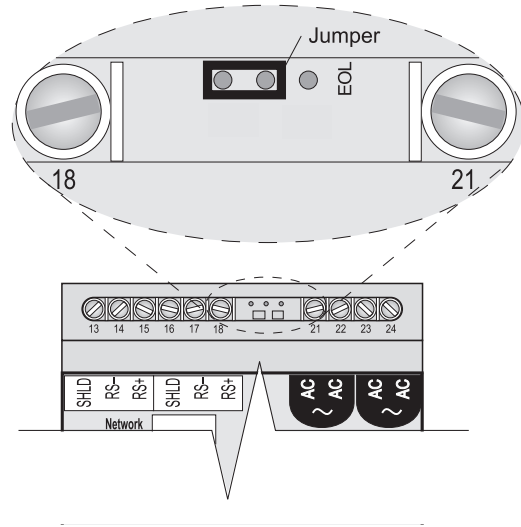

Figure 5b. End of Line Jumper for all other TTSIM's

### Leader Cable Connections for Sensor

The TTSIM-2 can be used with any of the TraceTek family of sensors including: TT1000, TT3000, TT5000 and TT5001 cables, as well as float switches and point probes. Connect the TraceTek leader cable to the TTSIM as shown in Figure 6.

Terminal	Color	Item
1	Red	Red / Green Sensor Cable Loop
2	Green	
3	Yellow	Yellow / Black Sensor Cable Loop
4	Black	

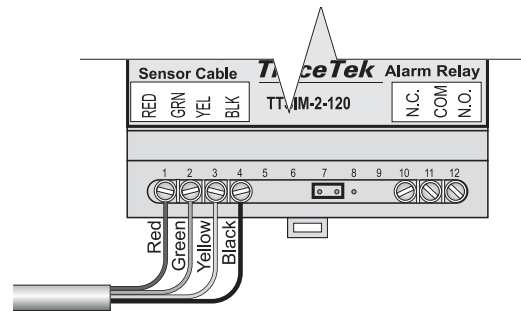

Figure 6. Sensing Cable Connections

**Network Address Assignment**

If the TTSIM-2 will be used in a TraceTek network, each module in a TraceTek network must have a unique address in the range 001 to 127. All TTSIM-2 units are shipped from the factory with their network address pre-set to a value above the range of valid addresses, in order to prevent communication conflicts during system startup and configuration. Each TTSIM must therefore be configured to a unique address before it can communicate with the TTDM-128 or other host.

To set the TTSIM-2 network addresses, repeat the following procedure for each TTSIM-2. Perform the complete procedure one module at a time:

- Place the TTSIM-2 configuration jumper in the CFG position, as shown in Figure 7a.
- Using the TTDM-128 or host system, assign the new TTSIM-2 address (refer to the TTDM-128 User Manual, H56853).
- Place the configuration jumper in the normal operating position, as shown in Figure 7b, or remove it completely (the jumper is not required in normal operation).
- Write the address in the space provided on the TTSIM-2 cover.

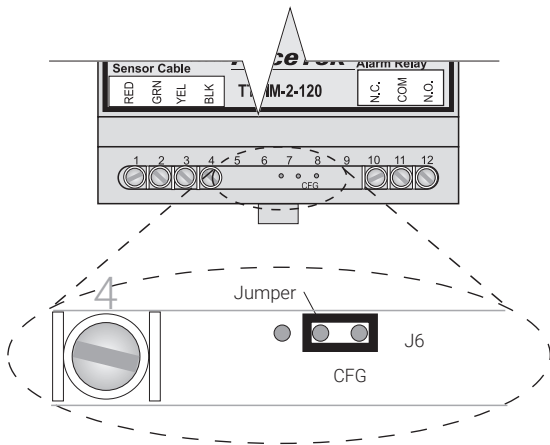

Figure 7a. Configuration Jumper in Configuration Position

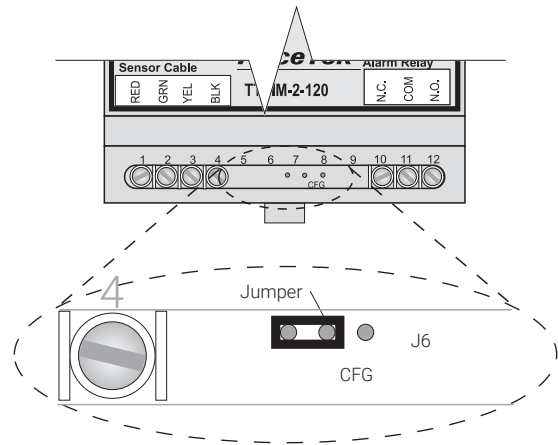

Figure 7b. Configuration Jumper set for Normal Operation

**Selecting location measurement units**

The TTSIM-2 can be configured to display leak location in either feet or meters. To select the desired units:

- Press the RESET button and hold it for approximately 3 seconds, until the display shows “Unt”.
- A small vertical bar in the LCD will appear next to either the Ft or M label. Press (but do not hold) the RESET button to select the desired units. When the vertical bar is next to the desired units, press and hold the RESET for 3 seconds to accept the setting and return to normal operation,

**Other configuration settings**

The TTSIM-2 has a number of configurable settings, including relay mode and operations and leak sensitivity. Refer to the TTDM-128 User Manual (H56853) for details on how to change these configurations.

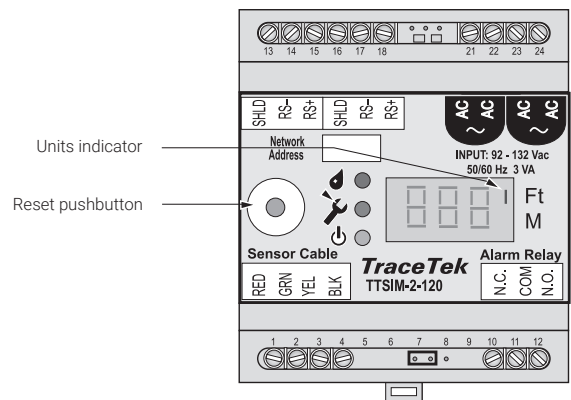

Figure 8. RESET pushbutton and units indicator locations

## Maintenance and Troubleshooting

**No user maintenance is required! There are no user adjustments or calibrations that can be performed in the field.**

Each TTSIM-2 is tested and calibrated at the factory. An operating TTSIM-2 runs a continuous self check routine and reports any discrepancies to the TTDM-128 or host computer.

If the TTSIM-2 or the network wiring fails in such a way that the TTSIM-2 cannot communicate with the host, then the host reports a communications failure.

### Status Indicators

There are 5 LEDs on the TTSIM-2 to indicate: power, communications (RX=inbound and TX=outbound), sensor status (leak detected and trouble). There is also a Reset pushbutton which is used to acknowledge or reset alarms or for updating the location display. See Figure 9 for the location of the LEDs and RESET pushbutton.

The green Power LED will be ON and will blink once every 5 seconds when the TTSIM-2 is powered and functioning correctly. Table 1 lists various sensor status conditions and possible corrective actions. Table 2 lists communication status conditions (applicable when the TTSIM-2 is used in a network system).

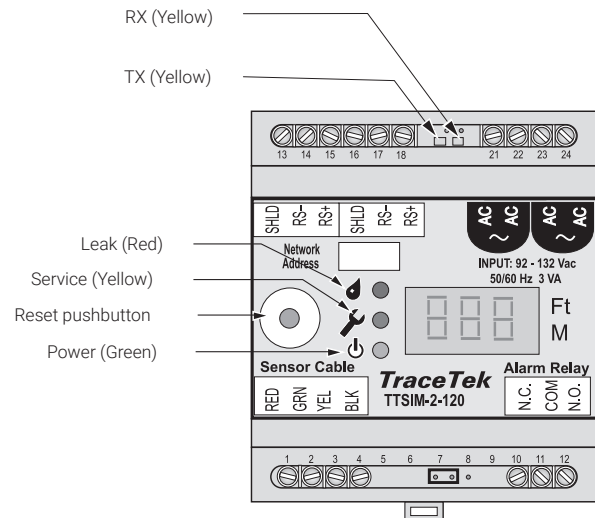

Figure 9. TTSIM-2 LED locations

Table 1. TTSIM-2 LED operational status indications

LEAK	SERVICE	INDICATION	USER ACTION
FLASH		Leak detected. Check sensor for leak or spill.	Preset reset to acknowledge
ON		Leak alarm has been reset by operator but the leak condition still exists	Press reset to clear alarm once leak is cleaned up
	FLASH	The sensor needs servicing. Check sensor and leadwires/jumpers for continuity or contamination.	Press reset to clear once problem is corrected

Table 2. TTSIM-2 communication status indications (only active if connected to a network)

TX	RX	INDICATION
FLASH	FLASH	Unit is communicating normally with TTDM-128 or host.
OFF	FLASH	Unit is receiving communication from TTDM-128 or host, but is not responding.
OFF	ON	RS-485 communication wires are reversed
OFF	OFF	Unit is not communicating with TTDM-128 or host.

#### North America

Tel +1.800.545.6258  
 Fax +1.800.527.5703  
 thermal.info@nvent.com

#### Europe, Middle East, Africa

Tel +32.16.213.511  
 Fax +32.16.213.604  
 thermal.info@nvent.com

#### Asia Pacific

Tel +86.21.2412.1688  
 Fax +86.21.5426.3167  
 cn.thermal.info@nvent.com

#### Latin America

Tel +1.713.868.4800  
 Fax +1.713.868.2333  
 thermal.info@nvent.com



nVent.com