



FIST-GCO2-F

Flat FIST Generic Closure Organizer

The generic closure FIST-GCO2-F is a compact version of CommScope's standard FIST-GCO2 closure. Like the FIST-GCO2, the FIST-GCO2-F is an environmentally sealed enclosure for the FIST fiber management system allowing splicing and passive component integration in the external network.

Features

- Single-ended design
- Base and dome sealed with latches and O-ring system
- Bases available with 6 round ports (drop cables) and 1 oval port (looped cables) or 8 round ports
- Single-sided UMS (Universal Mounting System) frame provides foundation for mounting combinations of SOSA2 (splice only sub-assembly) and/or FSASA2 (field-installable splitter array sub-assembly) modules, which consist of a modular grooveplate and trays
- Compatible with most common cable types: e.g. loose tube, central core, ribbon fiber
- Uncut fibers can be stored in trays
- Mounting ears available as part of the dome
- Well-suited for use in combination with heat shrink or multi-out gel seals
- Closure can be used in aerial, pedestal and underground (up to 5 meters waterhead) environments

FIST-GCO2-F

Flat FIST Generic Closure Organizer

Dimensions and Capacities

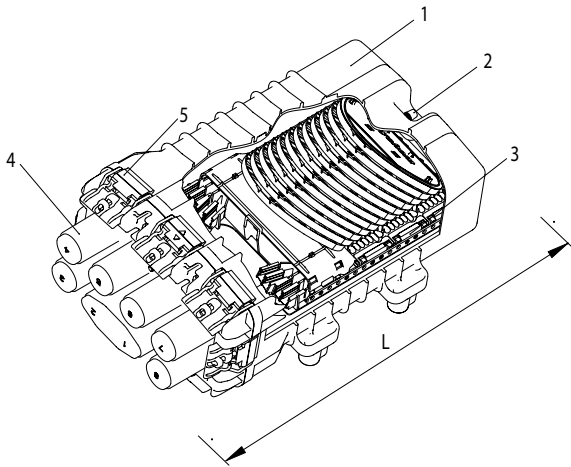

Key

- 1 Dome
- 2 Optional valve
- 3 Wrap-around grooveplates
- 4 Base
- 5 Latch

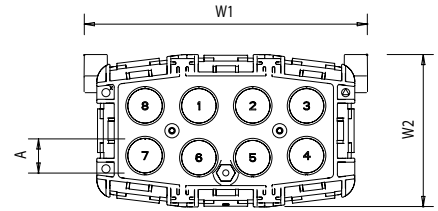
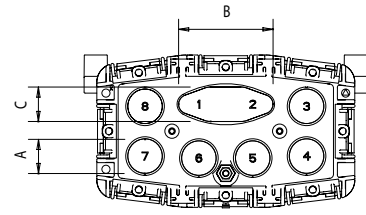

	GCO2-FC	GCO2-FD
Closure dimensions in mm		
Length (L)	384	432
Width at base (D)	279/150	279/150
Cable ports dimensions in mm		
Oval port (B/C)	82/30	82/30
Round ports (A/C)	30	30

Splice capacity	Fibers	Trays (16 UMS units) ¹	Fibers	Trays (24 UMS units) ¹
Single circuit splicing (2 primary coated fibers)	32	16	48	24
Single element splicing (12 primary coated fibers)	96	8	144	12
Ribbon fiber splicing (4/8-fiber)	64	8	96	12

¹ The space occupied by trays in the universal mounting system (UMS) is expressed as UMS units. One UMS unit equals 6mm. A single circuit tray occupies 1 UMS unit; a single element or 4/8 fiber ribbon tray occupies 2 UMS units; a 12-fiber ribbon tray requires 3 UMS units.

Capacities shown above are based on use of FIST-SOSA2 trays; capacity can be increased by the use of high-density versions of FIST-SOSA modules and trays. Please contact your local CommScope sales representative for more information.

FIST-GCO2-F

Flat FIST Generic Closure Organizer

Cable port capacity in mm	Heat shrink		Gel Seal					
	Oval port (2 cables/port)							
Minimum Ø	2x12		2x5					
Maximum Ø	2x25		2x18					
Round ports (6 or 8 depending on base chosen)	1 round cable/port		2 round cables/port	3 round cables/port	4 round cables/port	4 flat cables/port	8 round cables/port	16 round cables/port
	Heat shrink	Gel Seal	Gel Seal	Gel Seal	Gel Seal	Gel Seal	Gel Seal	Gel Seal
Minimum Ø	1x5	1x11	2x8	3x6.5	4x4	4x(6.5x11)	8x3	16x0
Maximum Ø	1x30	1x14	2x11	3x8	4x7	4x(6.5x11)	8x5	16x3

Ordering Information

FIST-GCO2 - XX X - X X

Type

FC	384mm long with 16 UMS units
FD	432mm long with 24 UMS units

Number of Ports

6	Round ports + 1 oval port
8	Round ports

Flash Test Valve

V	Pre-Installed flash test valve
N	No flash test valve

Ground feedthrough

G	Pre-Installed ground feedthrough
N	No ground feedthrough

Accessories

Cable Attachment Kits







Description	Quantity/package	Ordering number	
Universal strength member termination kit <ul style="list-style-type: none"> Metallic/non-metallic strength members Diameter range 1.5 – 5 mm Includes: 1 or 10 strength member terminations; 1 or 10 screws; 1 Allen key 	1 piece	FACC-UCT01	
	10 pieces	FACC-UCT10	
External cable fixation bracket <ul style="list-style-type: none"> Cable securing frame Mounts to base of closure with 2 screws Used in combination with FIST-GCO2-RSKG <p>Stores large quantities of small cables</p>		FIST-GCO2-FX6-EXT/CF	

FIST-GCO2-F

Flat FIST Generic Closure Organizer

Accessories (continued)

Heat Shrink Cable Sealing Kits

Description	Cable diameter range in mm (minimum/maximum)	Ordering number	
Heat shrink seal kits for oval ports			
<p>Single fiber loose tube cable</p> <ul style="list-style-type: none"> Seals 2 cables Includes plastic sleeve to store uncut loose buffer tubes on the backside of the UMS profile Includes 2 universal strength member termination kits 	12-25	FIST-GCO2-OSK-LTS	
<p>Central core cable</p> <ul style="list-style-type: none"> Seals 2 cables Includes metal bracket to terminate central core cables 	12-25	FIST-GCO2-OSK-CC	
Loose tube ribbon cable		FIST-GCO2-OSK-LTR	
<p>Wrap-around cable seal kit</p> <ul style="list-style-type: none"> Seals 2 cables Used in case of re-entry/repair 	-	FOSC-CSEAL-2NW	
Heat shrink seal kits for round ports			
<p>Single fiber loose tube cable</p> <ul style="list-style-type: none"> Seals 1 cable Includes universal strength member termination kit 	5-30	FIST-GCO2-RSK-LTS	
<p>Central core cable (single fiber and ribbon)</p> <ul style="list-style-type: none"> Seals 1 cable Includes metal cable fixation bracket and spiral tubing to terminate central core cables 	5-25	FIST-GCO2-RSK-CC	
Loose tube ribbon cable		FIST-GCO2-RSK-LTR	
<p>Wrap-around cable seal kit</p> <ul style="list-style-type: none"> Seals 1 cable Used in case of re-entry/repair 	-	FOSC-CSEAL-1NW	





FIST-GCO2-F

Flat FIST Generic Closure Organizer

Accessories (continued)

Multi-drop Cable Heat Shrink Seals for Round Ports

- Base with 6 to 8 round ports
- Port ø: 30mm
- Permits feeding of more than one cable through a round port
- Allows addition at a later date of cables to port already installed in the field
- Kits includes multi-termination plate with strength member fixations

Description	Diameter of first cable in mm	Diameter of additional cables in mm	Ordering number	
Kit for 1 cable and 2 tubes				
	14	9.5	FIST-GCO2-MULTI2/9	
	14	11.5	FIST-GCO2-MULTI2/11	
	12	12	FIST-GCO2-MULTI2/12	
Kit for single fiber loose tube cable (includes 3 tubes)				
		9.5	FIST-GCO2-MULTI3/9	
		11.5	FIST-GCO2-MULTI3/11	
For use with FIST-GCO2-MULTI kits				
Cable seal to seal cable onto tube			FIST-GCO2-MULTI-SEAL	
Multi-termination plate with 3 strength member fixations			FIST-GCO2-MULTHUCT	

FIST-GCO2-F

Flat FIST Generic Closure Organizer

Accessories (continued)

Gel-Seal Cable Sealing Kits for Oval and Round Ports

FIST - X S K G - X

Port Seal Type

○	Oval port seal
R	Round port seal

Port Seal

Round port seal	
1	1 cable ø 11-14 mm
2	2 cables ø 8-11 mm
3	3 cables ø 6.5-8 mm
4	4 cables ø 4-7 mm
4F	4 cables 6.5 x 11 mm
8	8 cables ø 3-5 mm
16	16 cables ø 0-3 mm
Oval port seal	
20*	Looped ø 16-20 mm
LEAVE BLANK	Looped ø 5-18 mm

* For FISTGCO2Bx closures only



www.commscope.com

Visit our website or contact your local CommScope representative for more information.

© 2015 CommScope, Inc. All rights reserved.

FIST and all trademarks identified by ® or ™ are registered trademarks or trademarks, respectively, of CommScope, Inc.

This document is for planning purposes only and is not intended to modify or supplement any specifications or warranties relating to CommScope products or services.

PS-319135.2-EU (12/15)